

# Yttrium <sup>1</sup>

## CABLE SUSPENDED (CS)

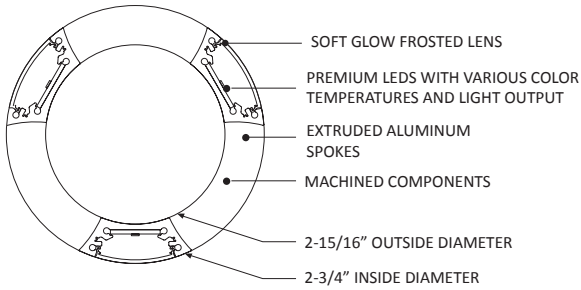

**FEATURES:**

- Clean Hollow Aesthetic
- Powered Suspension System - No power cord
- High transmission frosted lenses with no diode imaging
- No visible fasteners
- Extruded aluminum housing
- Dimmable/Programmable drivers for controllable light output
- High efficacy LEDs with 5 year warranty
- Under 2 steps MacAdams Ellipse Binning

**NOTES:**

- **REQUIRES REMOTE DRIVER(S)** (see page 4 for more info)



**PRODUCT SPECIFICATION**

**NOTE:** All options *italicized* may increase lead times and/or incur higher costs - please consult factory with questions.

FIXTURE TYPE	MOUNTING/ ORIENTATION	NOMINAL LENGTH*	COLOR TEMP	LED DRIVE POWER	VOLTAGE	DRIVER	HOUSING FINISH
Y2 Yttrium: 2 Spokes	CS Cable Suspended	1' 1'-1-3/8"	27K 2700K	VLO Very Low Output 400 lumens/ft (4w/ft.)	UNV Universal (120-277v)	ND Non-Dimming 0-10v DIMMING	SC Satin Clear Anodize (Standard)
Y3 Yttrium: 3 Spokes (2 up, 1 down)	CSV Cable Suspended - VERTICAL	2' 2'-1-3/8"	30K 3000K	LO Low Output 605 lumens/ft. (6w/ft.)	1V 120v	10D 10% DIM	SW Satin White (Powder Coat)
Y4 Yttrium: 4 Spokes		3' 3'-1-3/8"	35K 3500K	SO Standard Output 795 lumens/ft. (8w/ft.)	2V 227v	1D 1% DIM LUTRON	MB Matte Black (Powder Coat)
YC Custom Spoke Configuration		4' 4'-1-3/8"	40K 4000K	HO High Output 995 lumens/ft. (10w/ft.)	3V 347v*	LTEA Lutron Hi-Lume 1% (2-Wire)	CF Custom Finish* (Consult Factory)
		CR Continuous Run (Specify length in nominal feet)	50K 5000K	VHO Very High Output 1,115 lumens/ft. (12w/ft.)		LDE1 Lutron EcoSystem 1% "Soft on" (Digital)	
				CPO Custom Power Output Consult factory		LDES Lutron EcoSystem 5% 5-Series (Digital)	
						DALI Digital Addressable Lighting Interface	

\*Dimensions are for reference only. Contact factory for more specific information or shop drawings.  
 \*\*Odd lengths may incur slightly higher per foot pricing.  
 \*Not all dimming options are available with 347v.  
 \*RAL and color match are available.

HARDWARE* DETAIL FINISH	DRIVER HOUSING FINISH	CANOPY SIZE OPTIONS*	CANOPY FINISH	POWER CORD COLOR	AIRCRAFT CABLE LENGTH*	OPTIONS/ CUSTOMIZATION*
MF Machined Finish (Standard) CF Custom Finish (Consult Factory)	MA Mill Aluminium* SC Satin Clear SW Satin White SB Satin Black CF Custom Finish (Consult Factory)	44 4" Power feed canopy 4" Non-power feed canopy 41 4" Power feed canopy 1" Non-power feed canopy 40 4" Power feed canopy Canopy only at power feed	SW Satin White (Standard) MF Machined Finish MB Matte Black CF Custom Finish*	PSS Power Suspension System (No Power Cord) CC Custom Cord*	2 2' 4 4' 6 6' 8 8' CL Custom Length** (Specify in feet IE: CL10 for 10')	XX No EMB or Customization EMB7 7 Watt battery back-up** (Approximately 600 lumens) EMB12 12 Watt battery back-up** (Approximately 1,000 lumens) 90 90+ CRI LED BOARDS (2700K - 4000K only) CCP Corners/patterns* CD Custom Driver* CR Customization Requested*

NOTE: MF option is strongly recommended. Other options will result in higher costs and potentially longer lead times.  
 \*\*Hardware\* refers to the end caps and knuckles (knuckles only for the "Rotational" option).  
 \*Most cost effective.  
 \*CONTINUOUS RUNS REQUIRE THE 55" OR THE 44" OPTION. CONSULT FACTORY WITH QUESTIONS.  
 \*\*See options section and installation instructions for more information.  
 \*Consult the factory.  
 \*Cables are field adjustable.  
 \*\* Consult factory to confirm specific length.  
 NOTE: Customization may incur higher costs and/or increased lead times.  
 \*Consult the factory for all custom options or custom concept requests.  
 \*\*The EMB12 is slightly more expensive than the EMB7 option (BOTH OPTIONS ARE REMOTE ONLY).

**SPECIFICATION INFORMATION**

**GENERAL NOTES:**

All fixtures are **UL listed** for **dry** and **damp** locations.  
**REMOTE DRIVER** for all options.  
 Please contact the factory with any specification questions.  
*Italicized grayed* out options may incur additional costs and/or extended lead times. Please consult the factory.

**DRIVER: [REMOTE]**

- 1) NON-DIMMING: As described... this fixture will not dim.
- 2) DIMMING: 0-10v: 1%, 10% :: Lutron: 2-wire Forward phase (Hi-Lume 1%), Ecosystem to 1% (Soft On), Ecosystem to 5% (5 Series). "DALI" - Specify driver. See "Dimming Options" on subsequent pages for more information. For other dimming options, consult the factory.
- 3) EMERGENCY: Specify EMB under the Options/Customization category at the end of the cut sheet along with the desired lumen output (600 or 1,000 lumens - the latter is slightly more costly).
- 4) Drivers are programmed according to our standard lumen packages or to custom watt/lumen package requirements.
- 5) Consult factory with any questions or specification requirements.

**FINISHES:**

The standard finish is a Satin Clear anodized housing with Machine Finished hardware. Machined finish is preferable for machined components (Hardware Detail) - Powder coating these parts may result in additional costs. Consult the factory with any questions about standard or custom finishing options.

**CUSTOMIZATION\*:**

We have numerous custom options available. However, if there is something unique required for a project, from simple options to complete custom requests, we are more than willing to entertain any creative notions you might have. Just ask.



## PRODUCT SPECIFICATION

- Fixture delivered light potential: 101 Lumens/Watt\*
- Uniform light distribution
- 90+ CRI LED diode options
- Exceptional binning- less than 2 step MacAdams Elipse
- Minimum 70% initial lumen output at 70,000 hours
- Standard 0-10v dimming to %10
- Lutron, Eldoled, Dali, and other dimming options
- 5 year system warranty

\*Actual fixture efficacy will be dependent on specification. Higher lumens per watt are achieved with lower drive powers. Please contact the factory with questions or for more information.

## LUMEN OUTPUT\*

DRIVER OUTPUT	LUMEN OUTPUT (PER FOOT)	
	WATTAGE	LUMENS
VERY LOW (VLO)	7.75	800
LOW (LO)	11.5	1,210
STANDARD (SO)	16	1,585
HIGH (HO)	19.5	1,985
VERY HIGH (VHO)	23.5	2,310

DRIVER OUTPUT	PER 4' FIXTURE (TOTAL DELIVERED LUMENS)	
	WATTAGE	LUMENS
VERY LOW (VLO)	31	3,200
LOW (LO)	46	4,840
STANDARD (SO)	64	6,340
HIGH (HO)	78	7,940
VERY HIGH (VHO)	94	9,240

**VERY LOW:** Considerably underdrives the LEDs to maximize fixture efficacy potential and limit wattage use.

**LOW:** Underdrives the LEDs for reasonable light output while maintaining low wattage use.

**STANDARD:** Drives the LEDs for the best combination of lumen output and fixture efficacy.

**HIGH:** Drive the LEDs at higher capacity for higher lumen output with good efficacy.

**VERY HIGH:** Drives the LEDs at the highest capacity for the highest lumen output with the best efficacy.

\*Lumen output will vary depending on ambient temperature. Cooler ambient and LED color temperatures result in higher luminaire performance. Calculations are based on 4000K LEDs.

## LUMINOUS INTENSITY DISTRIBUTION

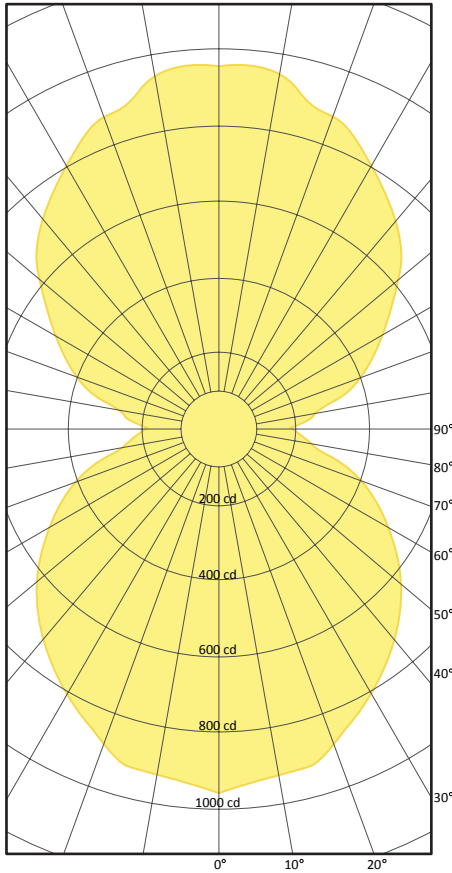

## FIXTURE PROPERTIES (AS TESTED)

- 4' nominal length fixture
- Standard Output (SO)
- Total system energy consumption: 64 Watt
- 101 Lumens/Watt
- 4000K 80 CRI LED

## ZONAL LUMEN SUMMARY

ZONE	LUMEN	%LAMP	%FIXTURE
0 - 30	711	8.2%	11.2%
0 - 40	1,171	13.6%	18.5%
0 - 60	2,161	25%	34.1%
0 - 90	3,169	36.7%	50%
90 - 120	1,007	11.7%	15.9%
90 - 150	2,459	28.5%	38.8%
90 - 180	3,170	36.7%	50%
0 - 180	6,339	73.4%	100%

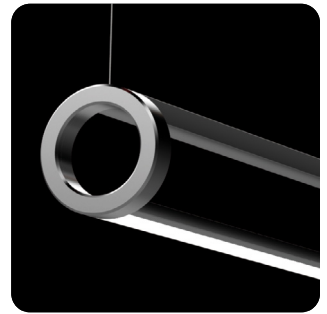
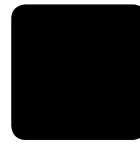

## PRODUCT SPECIFICATION

- Fixture delivered light potential: 103 Lumens/Watt\*
- Uniform light distribution
- 90+ CRI LED diode options
- Exceptional binning- less than 2 step MacAdams Elipse
- Minimum 70% initial lumen output at 70,000 hours
- Standard 0-10v dimming to %10
- Lutron, Eldoled, Dali, and other dimming options
- 5 year system warranty

\*Actual fixture efficacy will be dependent on specification. Higher lumens per watt are achieved with lower drive powers. Please contact the factory with questions or for more information.

## LUMEN OUTPUT\*

DRIVER OUTPUT	LUMEN OUTPUT (PER FOOT)	
	WATTAGE	LUMENS
VERY LOW (VLO)	11.5	1,200
LOW (LO)	18.5	1,815
STANDARD (SO)	23	2,380
HIGH (HO)	29.5	2,980
VERY HIGH (VHO)	35.5	3,465

DRIVER OUTPUT	PER 4' FIXTURE (TOTAL DELIVERED LUMENS)	
	WATTAGE	LUMENS
VERY LOW (VLO)	46	4,800
LOW (LO)	74	7,260
STANDARD (SO)	92	9,520
HIGH (HO)	118	11,920
VERY HIGH (VHO)	142	13,860

**VERY LOW:** Considerably underdrives the LEDs to maximize fixture efficacy potential and limit wattage use.

**LOW:** Underdrives the LEDs for reasonable light output while maintaining low wattage use.

**STANDARD:** Drives the LEDs for the best combination of lumen output and fixture efficacy.

**HIGH:** Drive the LEDs at higher capacity for higher lumen output with good efficacy.

**VERY HIGH:** Drives the LEDs at the highest capacity for the highest lumen output with the best efficacy.

\*Lumen output will vary depending on ambient temperature. Cooler ambient and LED color temperatures result in higher luminaire performance. Calculations are based on 4000K LEDs.

## LUMINOUS INTENSITY DISTRIBUTION

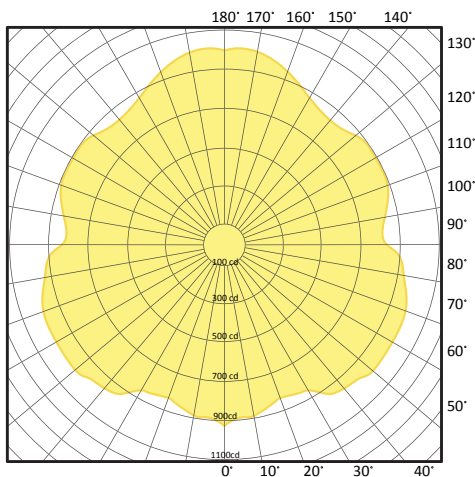

## FIXTURE PROPERTIES (AS TESTED)

- 4' nominal length fixture
- Standard Output (SO)
- Total system energy consumption: 92 Watt
- 103 Lumens/Watt
- 4000K 80 CRI LED

## ZONAL LUMEN SUMMARY

ZONE	LUMEN	%LAMP	%FIXTURE
0 - 30	716	5.5%	7.5%
0 - 40	1,224	9.4%	12.9%
0 - 60	2,564	19.8%	27%
0 - 90	4,865	37.6%	51.2%
90 - 120	2,024	15.6%	21.3%
90 - 150	3,838	29.6%	40.4%
90 - 180	4,646	35.9%	48.8%
0 - 180	9,511	73.4%	100%

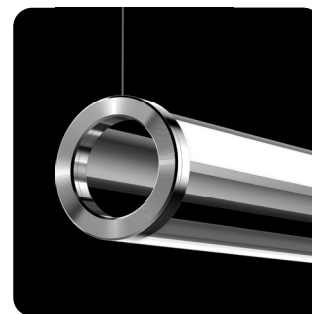

## PRODUCT SPECIFICATION

- Fixture delivered light potential: 96 Lumens/Watt\*
- Uniform light distribution
- 90+ CRI LED diode options
- Exceptional binning- less than 2 step MacAdams Elipse
- Minimum 70% initial lumen output at 70,000 hours
- Standard 0-10v dimming to %10
- Lutron, Eldoled, Dali, and other dimming options
- 5 year system warranty

\*Actual fixture efficacy will be dependent on specification. Higher lumens per watt are achieved with lower drive powers. Please contact the factory with questions or for more information.

## LUMEN OUTPUT\*

DRIVER OUTPUT	LUMEN OUTPUT (PER FOOT)	
	WATTAGE	LUMENS
VERY LOW (VLO)	16	1,600
LOW (LO)	22.5	2,420
STANDARD (SO)	33	3,170
HIGH (HO)	39	3,970
VERY HIGH (VHO)	46.5	4,620

DRIVER OUTPUT	PER 4' FIXTURE (TOTAL DELIVERED LUMENS)	
	WATTAGE	LUMENS
VERY LOW (VLO)	64	64,000
LOW (LO)	90	9,680
STANDARD (SO)	132	12,680
HIGH (HO)	156	15,880
VERY HIGH (VHO)	186	18,480

**VERY LOW:** Considerably underdrives the LEDs to maximize fixture efficacy potential and limit wattage use.

**LOW:** Underdrives the LEDs for reasonable light output while maintaining low wattage use.

**STANDARD:** Drives the LEDs for the best combination of lumen output and fixture efficacy.

**HIGH:** Drive the LEDs at higher capacity for higher lumen output with good efficacy.

**VERY HIGH:** Drives the LEDs at the highest capacity for the highest lumen output with the best efficacy.

\*Lumen output will vary depending on ambient temperature. Cooler ambient and LED color temperatures result in higher luminaire performance. Calculations are based on 4000K LEDs.

## LUMINOUS INTENSITY DISTRIBUTION

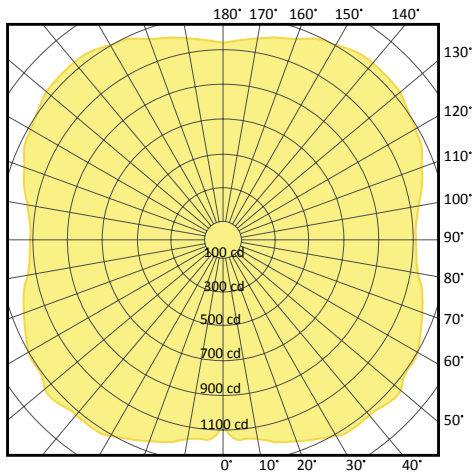

## FIXTURE PROPERTIES (AS TESTED)

- 4' nominal length fixture
- Standard Output (SO)
- Total system energy consumption: 132 Watt
- 96 Lumens/Watt
- 4000K 80 CRI LED

## ZONAL LUMEN SUMMARY

ZONE	LUMEN	%LAMP	%FIXTURE
0 - 30	969	5.6%	7.6%
0 - 40	1,685	9.8%	13.3%
0 - 60	3,501	20.3%	27.6%
0 - 90	6,341	36.7%	50%
90 - 120	2,840	16.4%	22.4%
90 - 150	5,371	31.1%	42.3%
90 - 180	6,342	36.7%	50%
0 - 180	12,683	73.4%	100%

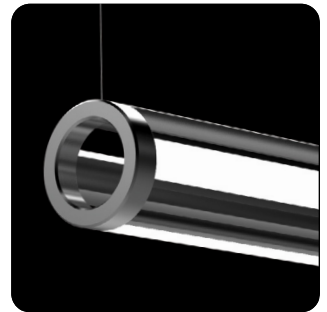
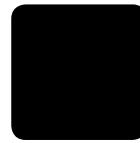

# REMOTE DRIVER HOUSING INFORMATION



## REMOTE DRIVER HOUSING SIZES

The driver housing length is typically dictated by the options selected. Standard driver housing lengths are as shown. Non standard driver requests may increase or decrease the driver housing length. Specifications are subject to change without notice. Consult factory with questions, requests, or size limitations and we will do our best to accommodate your needs.

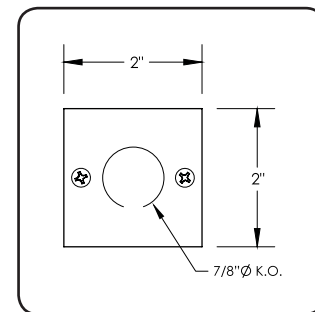
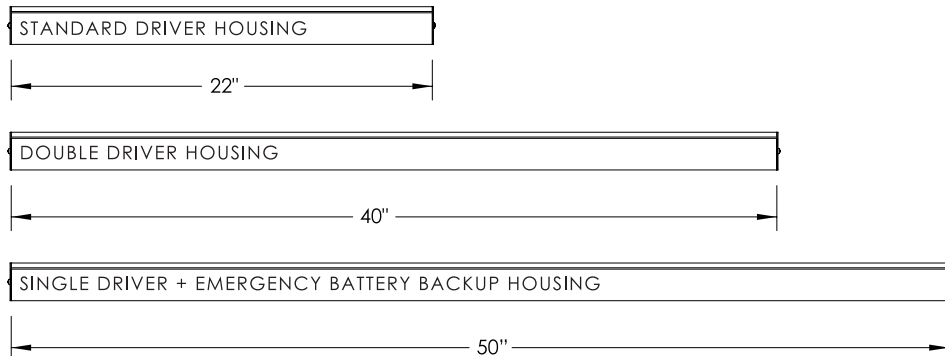

DRIVER HOUSING PROFILE

## INSTRUCTIONS

See below for lid removal and installation instructions.

To remove the driver housing lid, use a broad slot screwdriver in the channel as shown here and twist the screwdriver ninety degrees. This may need to be done at both ends of the housing or multiple locations depending on the driver housing length.

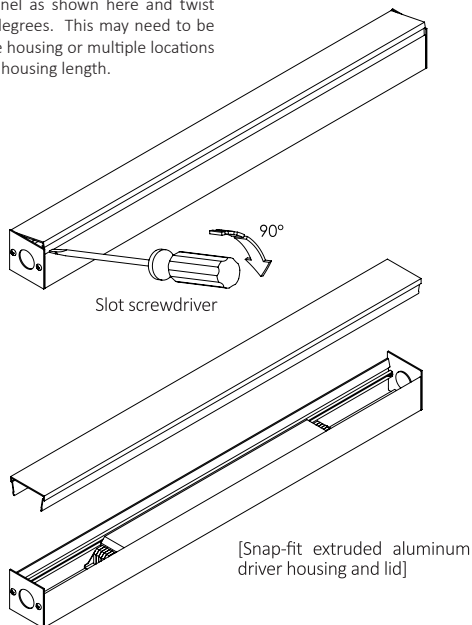

1) Drill mounting holes in the driver housing as needed to secure to a suitable surface. (If needed, a power feed hole can be drilled into the bottom of the housing for certain mounting/power feed applications).

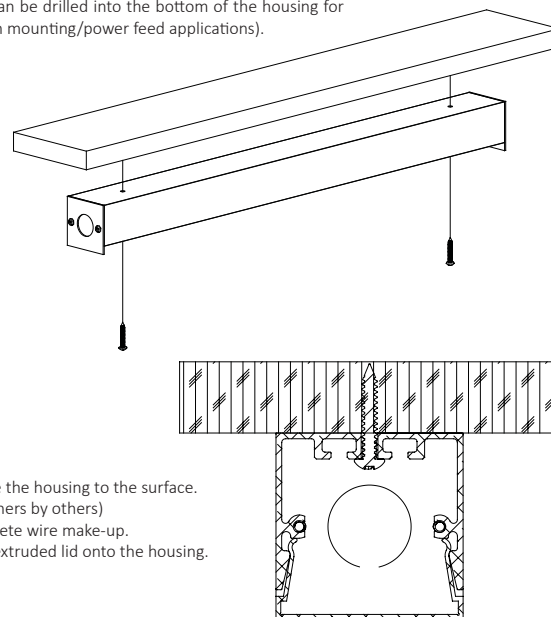

## FINISHES

Mill Aluminum (MA) is the standard finish. Satin White and Satin Black powder coat and Satin Clear anodized finishes can be done for a small charge. Custom finishes are possible. Contact the factory for specific finish options, specific requests, RAL colors, or any other questions.

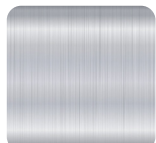

Mill Aluminum (MA)  
[Standard Finish]



Satin White (SW)  
[Upgrade Finish]



Satin Black (SB)  
[Upgrade Finish]



Satin Clear (SC)  
[Upgrade Finish]



Custom Finish (CF)  
[Upgrade Finish]



## NOTES

Other options are possible. Please contact the factory with custom requests.



Lumium Lighting, LLC | 3590 Cadillac Ave, Suite A, Costa Mesa, CA 92626 | Phone: 760.757.2530 | Fax: 760.283.2333 | [www.lumiumlighting.com](http://www.lumiumlighting.com)

While we always strive to ensure all website content and product information is current, Lumium Lighting reserves the right to change specifications without notice. © Lumium Lighting, LLC - All rights reserved.

0818



**Lumium**  
lighting at its element

# OPTIONS GUIDE

## MOUNTING

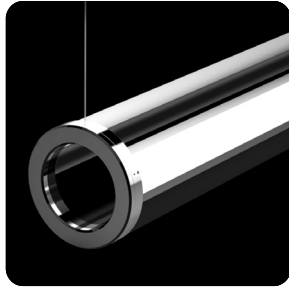
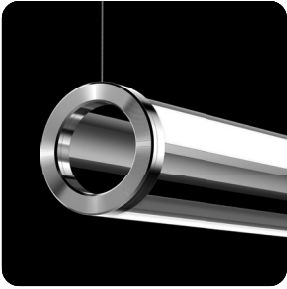

### CABLE SUSPENDED (CS)

Power Suspension System. Yttrium (Y) is static down-light and up-light: Bi-Directional (CS). Standard and custom power cord finishes, sleeve options, and canopy colors offer options to match almost any space. Stainless steel cables come in various lengths (4' is standard) and are field adjustable.

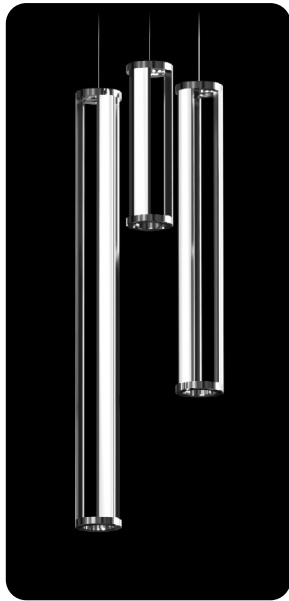

### CABLE SUSPENDED (CSV)

Power Suspension System. Yttrium (Y) can be a static Bi-Directional light hung up-right (CSV). Standard and custom power cord finishes, sleeve options, and canopy colors offer options to match almost any space. Stainless steel cables come in various lengths (4' is standard) and are field adjustable.

